

Welcome to Family Learning

Shape

Why shape?

The observation of the same and different.

Discussing how objects relate to each other.

Observing similarities and differences.

Making links.

Provides a foundation for more advanced skills.

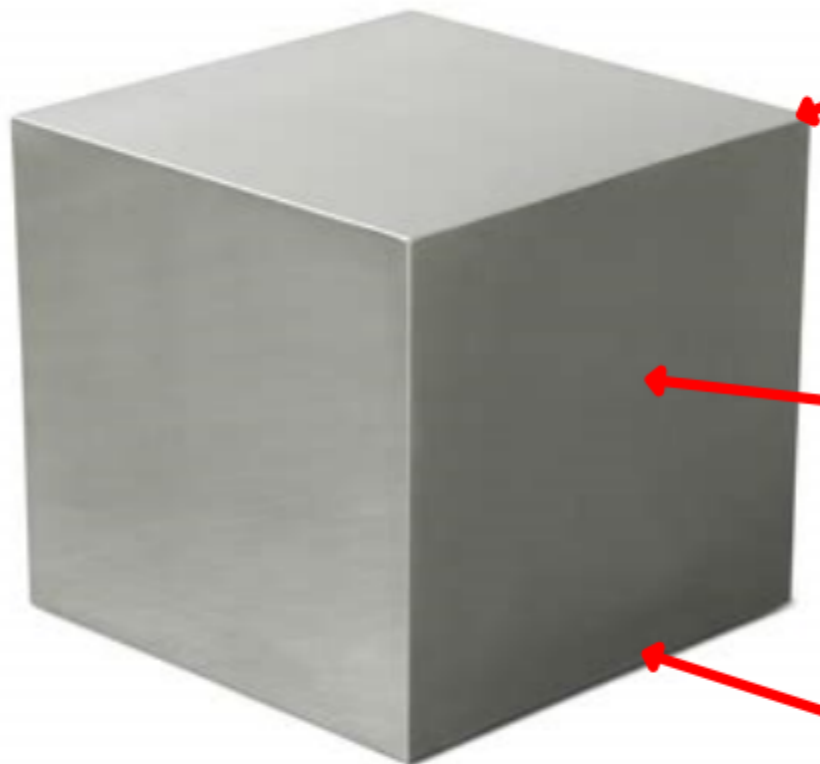

vertex (s)

vertices (pl)

face

edge

3D Shapes and their Properties

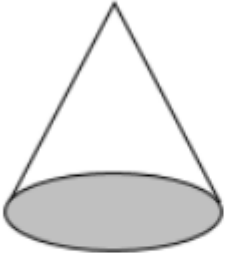
Shape	Properties	Real world
	<p>This 3D shape is a _____.</p> <p>It has _____ faces, _____ vertices and _____ edges.</p>	
	<p>This 3D shape is a _____.</p> <p>It has _____ faces, _____ vertices and _____ edges.</p>	

Nets

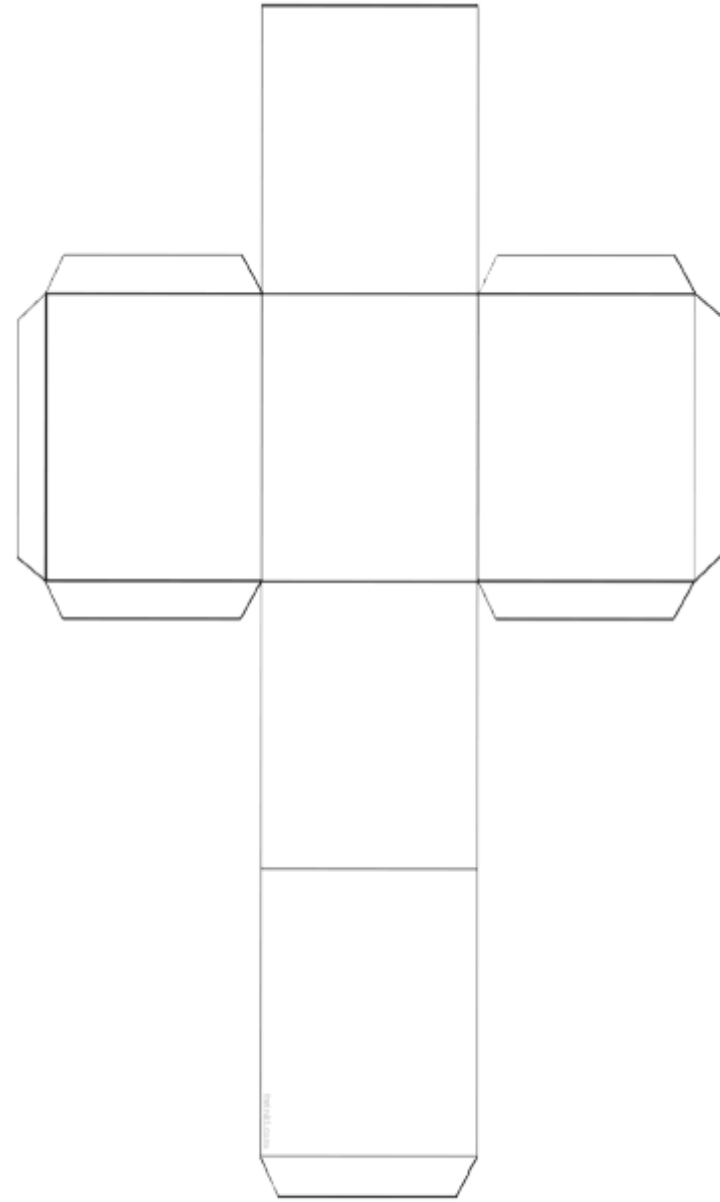
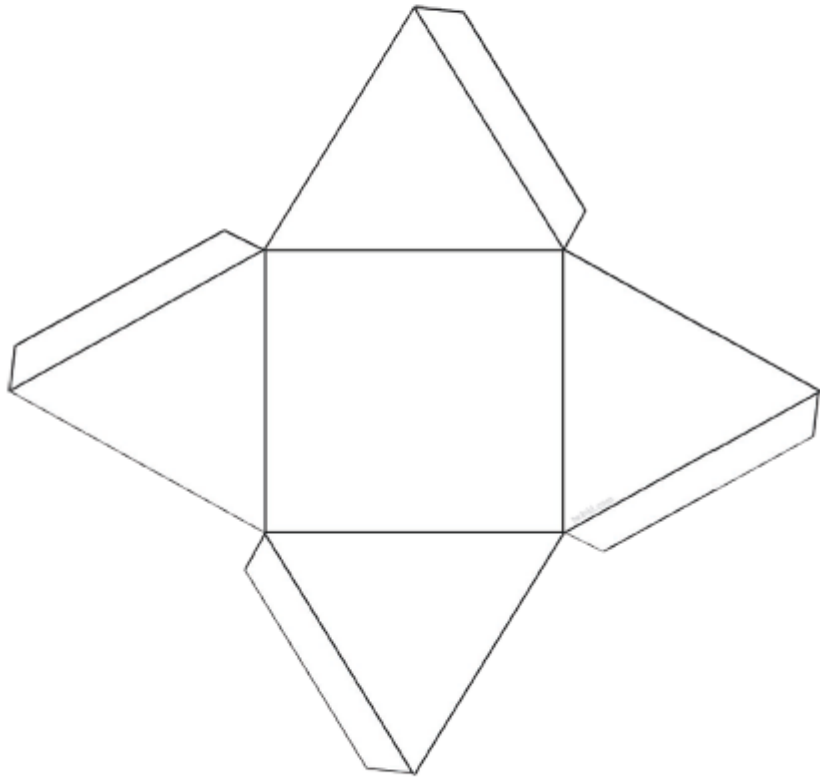

Using only...



Make...

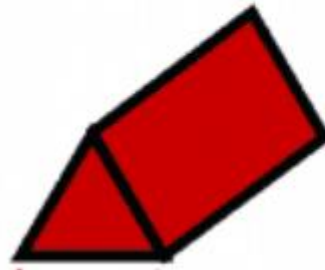
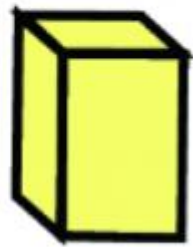

3D shape nets

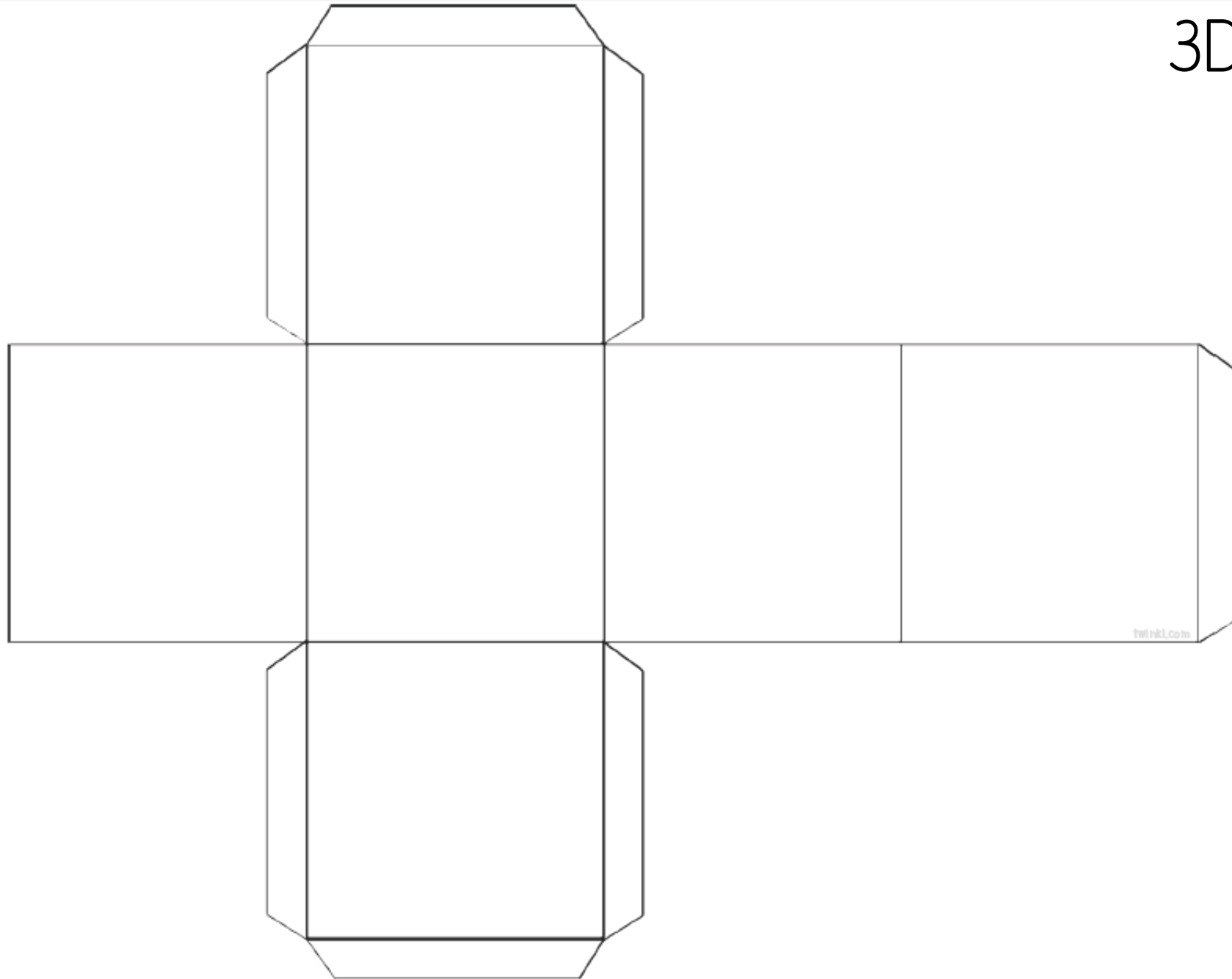

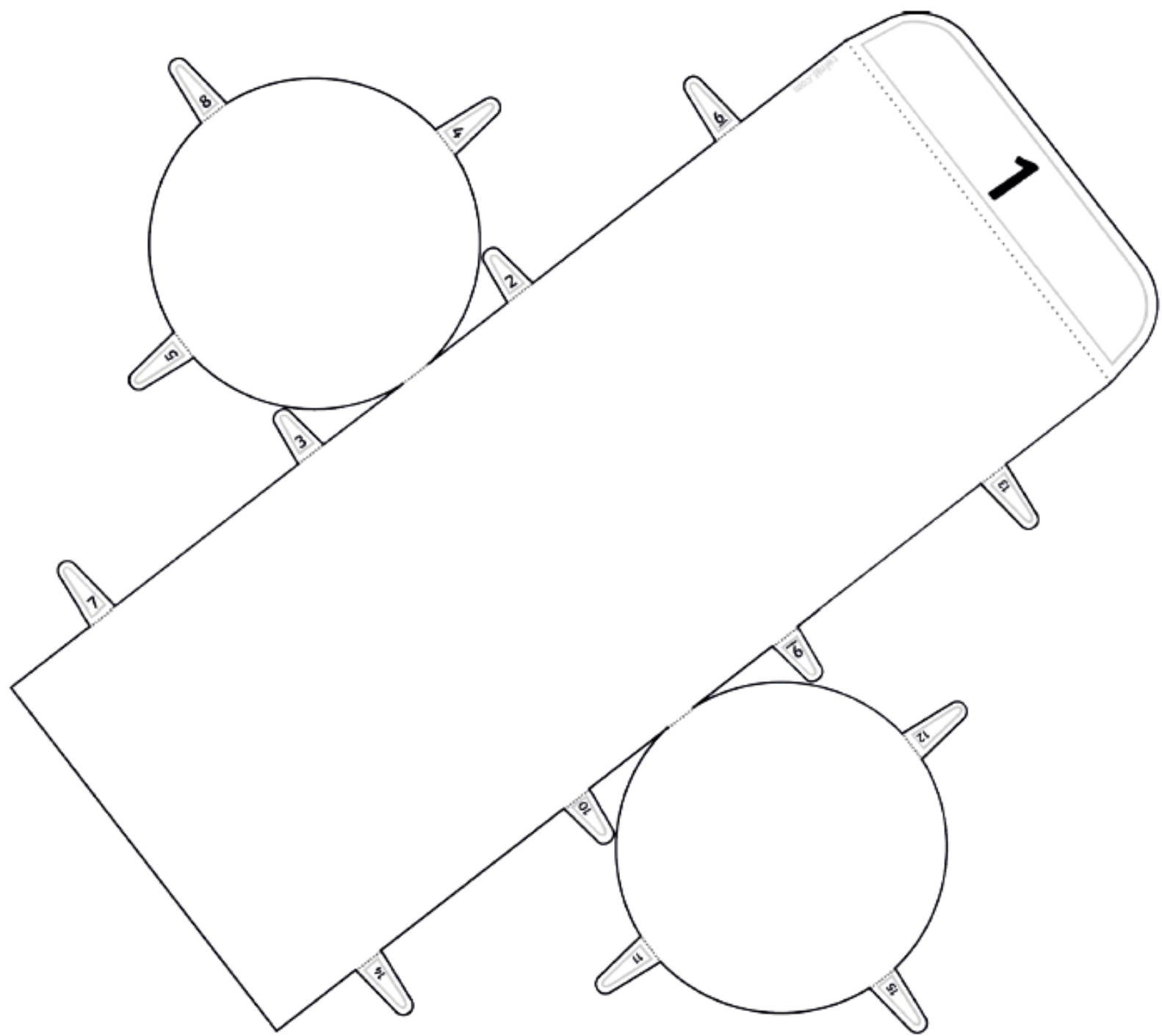

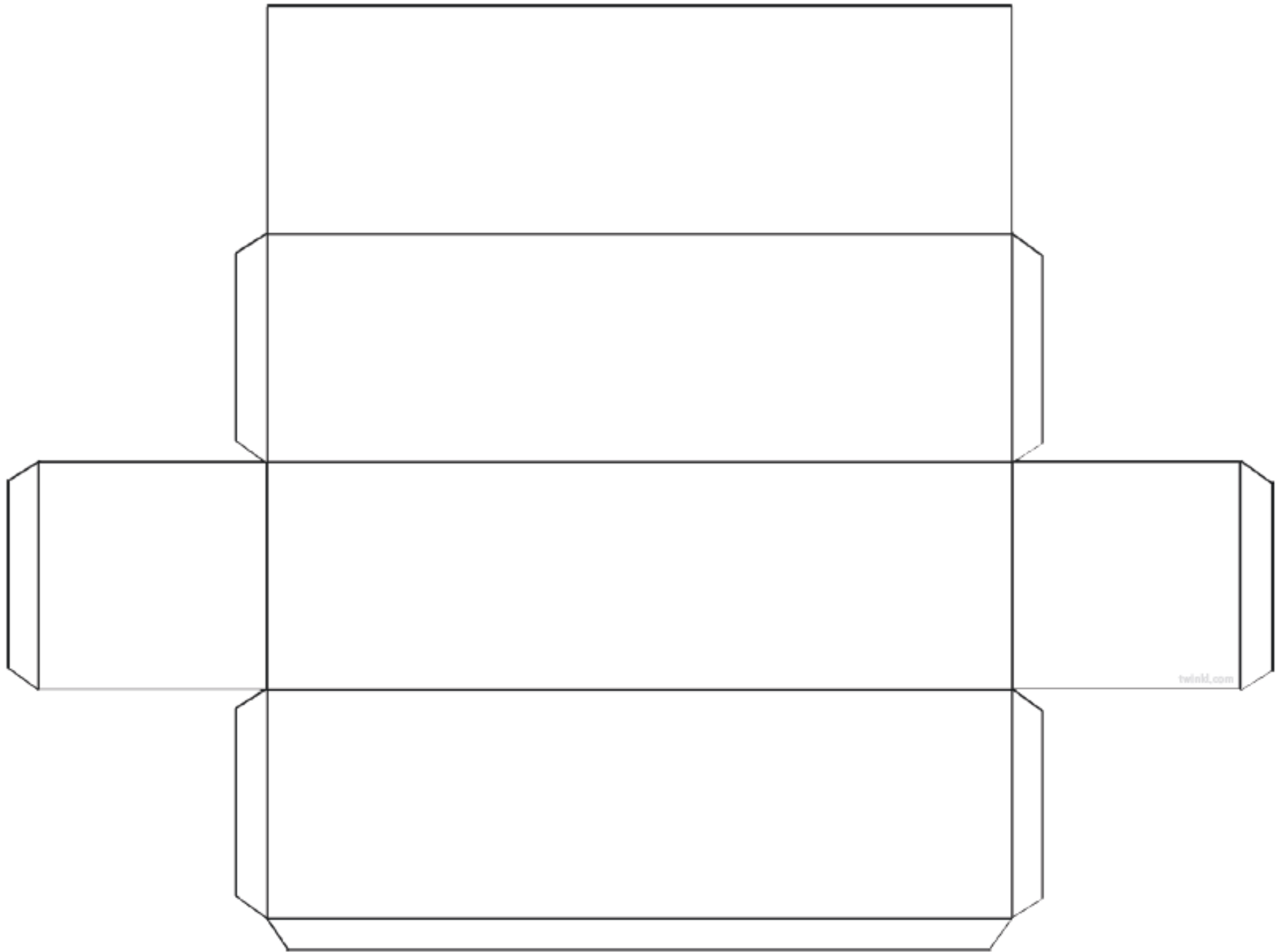

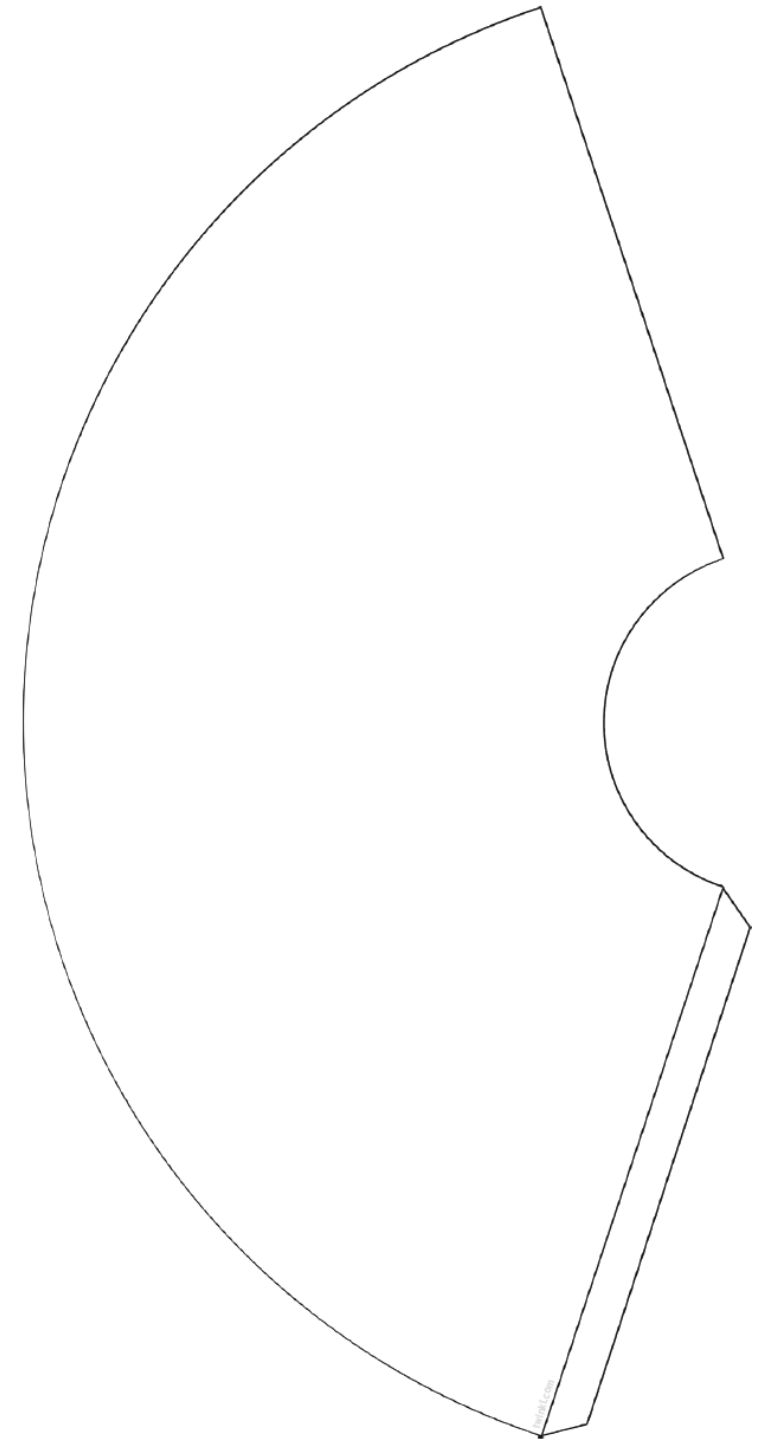
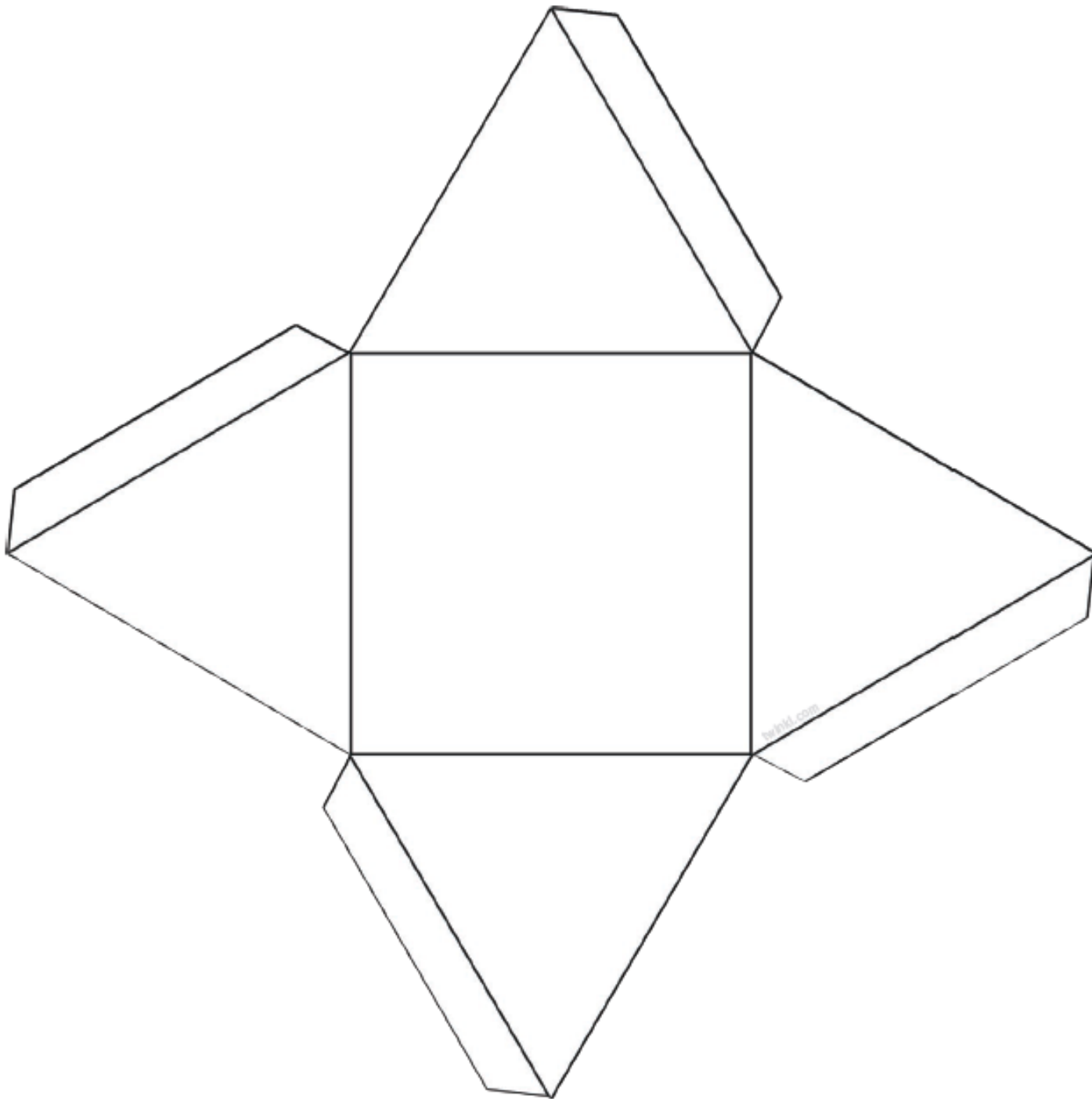

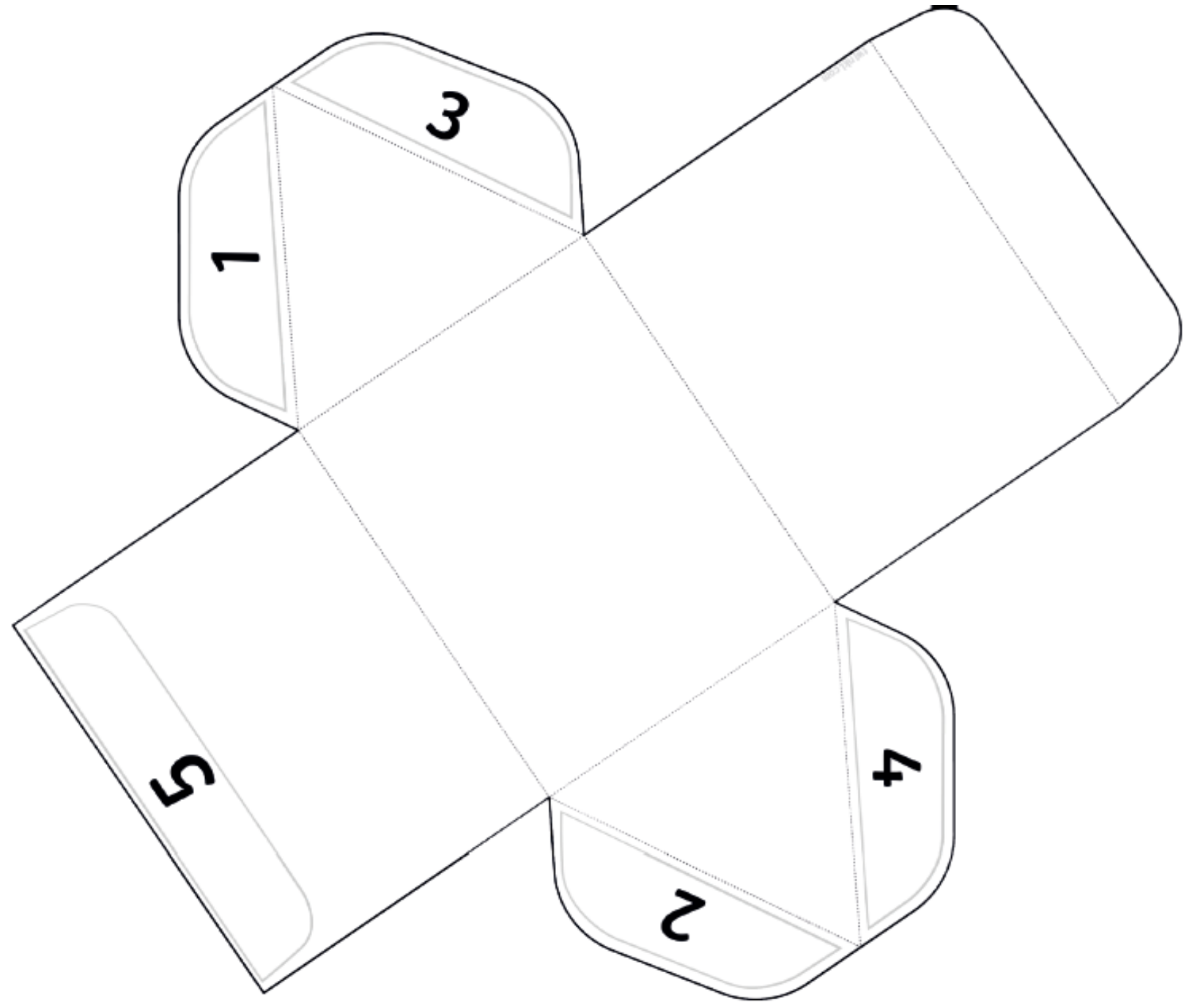



Thank you